

FREX 700

Flybarless System

INSTRUCTION MANUAL

ALIGN













Lightweight! Agile! Precise!
Programmable

FL760

3G

Flybarless System

Page	Contents
1	Safety Notes
2	Features
2	Package Contents
3-5	Flybarless Head Assembly Instruction
6	Parts Identification And Connection Illustration
6	Setup Indicators
7	Control Unit And Sensor Installation
7-16	Usage and Setup instructions
17-18	3G Flybarless Preflight Check
19-20	3G Flybarless Flight Test Procedure
20	Setup Examples
21	Troubleshooting
22	Q & A
22	Specifications









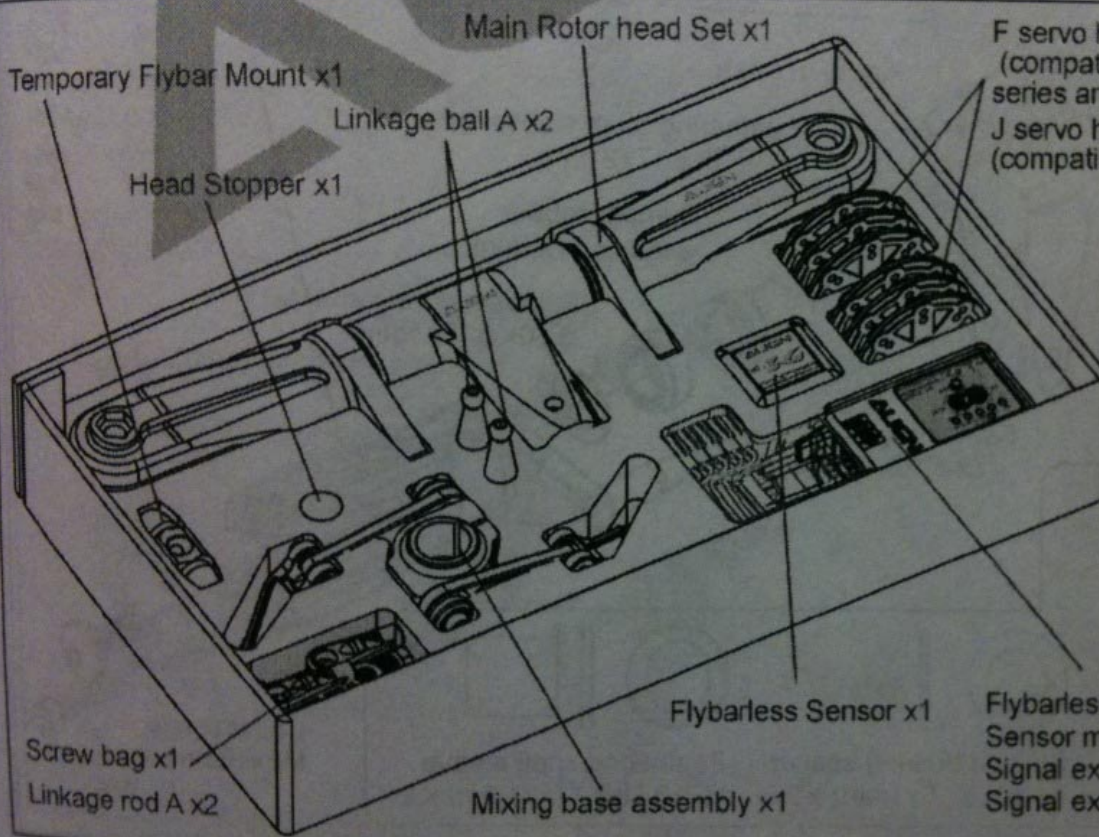

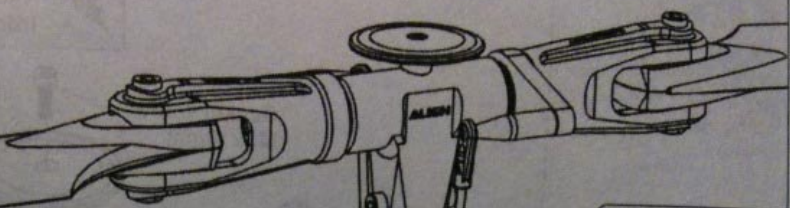





We appreciate your purchase of Align products.

Please read the manual carefully before assembling and follow all precautions and recommendations located within the manual. Be sure to retain the manual for future reference.

3 PACKAGE CONTENTS





Ball Links x4
(use with link rod D)

Linkage rod(D) Approx. 67.2mm x 2

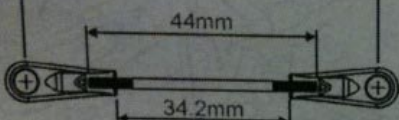

Use the inner hole
(24.4mm horn diameter)



Use new parts from this kit

Use existing linkage rod D

Warning

For safety reasons, newer premium CCPM servos are recommended to avoid inconsistencies created by gear wears and motor deteriorations of older servos.

Recommended servo spec:
minimum speed 0.10 sec/60°, torque 12kg cm or higher

F servo horns:
Compatible with Align DS6xx series and Futaba servos

Use new parts from this kit

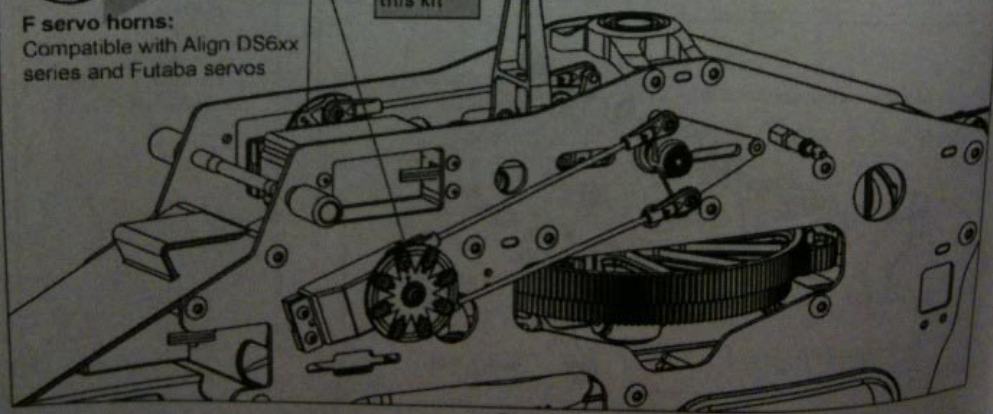

PARTS IDENTIFICATION AND CONNECTION ILLUSTRATION

Flybarless Sensor



Flybarless Control Unit

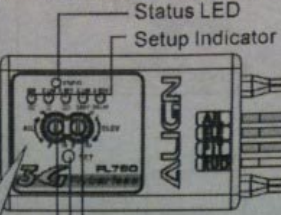

Insert plugs into receiver as per labels

- AILERON
- ELEVATOR
- PITCH Duo-receiver
- RUDDER and Duo-BEC
- SENSITIVITY

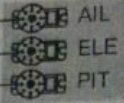

The systems for swashplate and the rudder are in independent circuits, supporting Duo-receiver and Duo-BEC. (Example: Swashplate servo 7.4V and rudder servo 5.2V)

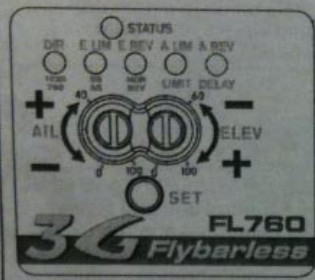
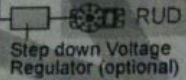

The default factory setting for aileron and elevator gain is 50% (dial turned to 12 o'clock position). If left/right or forward/aft oscillation is noticed, reduce the AIL or ELE gain 10 degrees at a time, until the oscillation disappears.

If helicopter drifts left/right or forward/aft during hover, increase the AIL or ELE gain 10 degrees at a time until drifting is eliminated.

6 · 3G FLYBARLESS SETUP INDICATORS

Flybarless system setup mode:

<p>DIR</p> <p>Mechanical endpoints and neutral point settings</p>	<p>E.LIM</p> <p>Collective mixing type recognition and elevator endpoint settings</p>	<p>E.REV</p> <p>Elevator reverse settings</p>	<p>A.LIM</p> <p>Aileron endpoints settings</p>	<p>A.REV</p> <p>Aileron reverse settings</p>
--	--	--	---	---

Rudder gyro setup mode:

<p>1520/760</p> <p>Servo frame rate settings (1520 Hz and 760 Hz)</p>	<p>DS/AS</p> <p>Digital/Analog servo settings</p>	<p>NOR/REV</p> <p>Rudder Servo Reverse settings</p>	<p>LIMIT</p> <p>Rudder endpoints settings</p>	<p>DELAY</p> <p>Rudder servo delay and helicopter size settings</p>
--	--	--	--	--

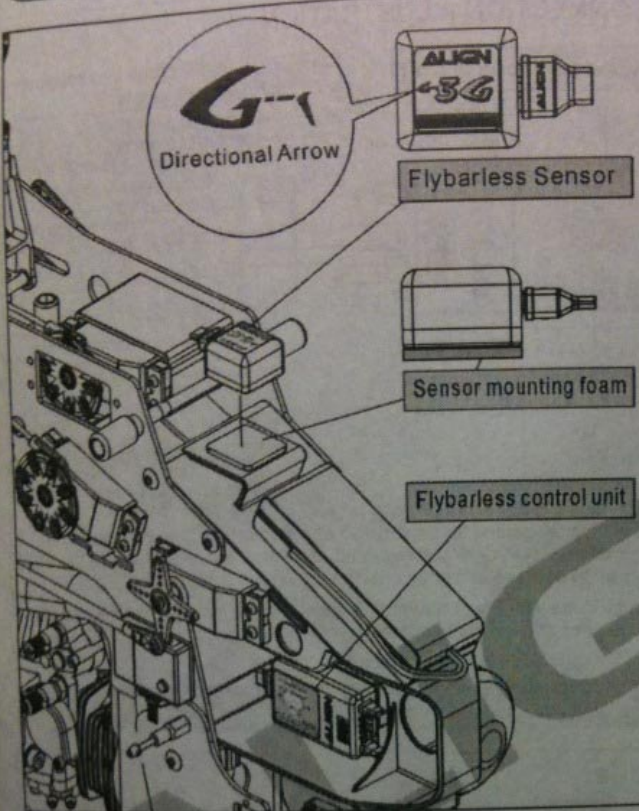

Directional Arrow

Flybarless Sensor

Sensor mounting foam

Flybarless control unit

CAUTION

Sensor must be installed with arrow pointing to **front** or **rear** of the helicopter as shown in diagram, **level**, and away from vibration sources. If excess vibration from helicopter frame is affecting flybarless sensors causing instability, two sensor foams can be used to mount the sensor. If problem persists, attempts should be made to eliminate vibration source, or reduce headspeed.

CAUTION

Positive connection of signal wires between control unit and sensor must be confirmed and rechecked as pre-flight check, with sufficient slack to avoid vibrations induced disconnects. Disconnects during flight will result in loss of control and crash of the model.

8 · USAGE AND SETUP INSTRUCTIONS

ALIGN

SETUP PRE-CHECK

1. Connect the receiver and servos to the flybarless control unit as per diagram found on page 6
2. Digital servos must be used on cyclic to avoid damage to servos.
Recommended servo spec: minimum speed 0.10 sec/60, torque 12kg. cm or higher.
3. Subtrims on transmitter must be zeroed during the setup process, and can be added during flight tuning.
4. 3G Flybarless contains two independent power circuits to enable the use of different voltage sources through the receiver (For example, 7.4V to the cyclic servos, 5V to the gyro and rudder servo).
If there is only one 7.4V power source, a step down voltage regulator is required (available separately) to prevent rudder servo from burning out.

CAUTION

To prevent voltage instability, do not use step down voltage regulator if power source is already at 5V. Please consult your servo manuals and ensure proper voltage are supplied to the servos.

5. When the 3G flybarless system is installed for the first time, a few simple setup steps and fly tests need to be performed in the flybarless setup mode. These steps need to be performed only during initial setup, and does not need to be repeated for subsequent flights. Just power up the system normally, check the proper servo operations, and fly. The initial setup procedure only need to be repeated after software upgrade, pitch range reset, or subtrims are added in the transmitter.

FLYBARLESS SYSTEM INITIAL SETUP STEPS

1. DIR: Flybarless mechanical endpoint and neutral setting mode

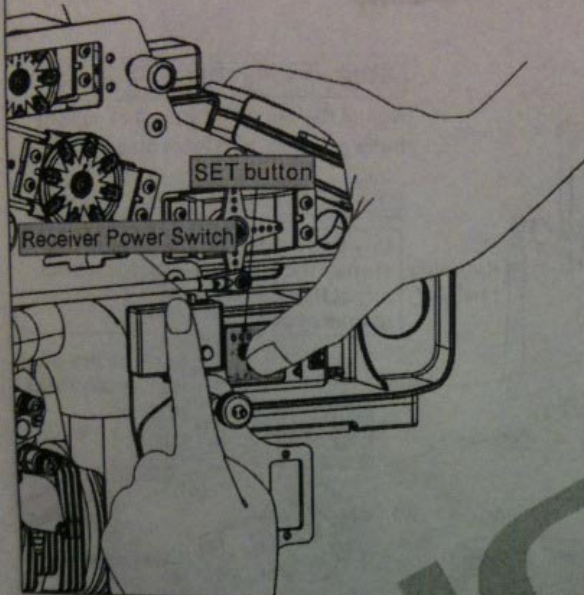

Step 1 : Enter the DIR settings

Press and hold the "SET" button while powering up the receiver. Release the button when LED 1-5 begin to cycle. The "DIR" green LED will light up indicating the mechanical endpoint and neutral point settings.

CAUTION

If "STATUS" led flashes in red indicating error entering DIR settings, check connections to the sensor and restart the process.

DIR settings



Transmitter function to servo mapping

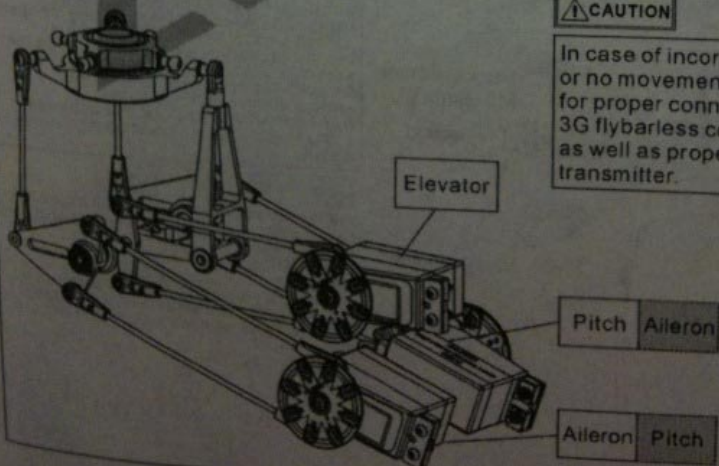

Step 2 : Swashplate function check

Verify the correct swashplate movements for PIT, AIL, and ELE inputs.

CAUTION

In case of incorrect servo movement or no movement at all, please check for proper connection between 3G flybarless connection to servos, as well as proper setup on transmitter.

DIR settings



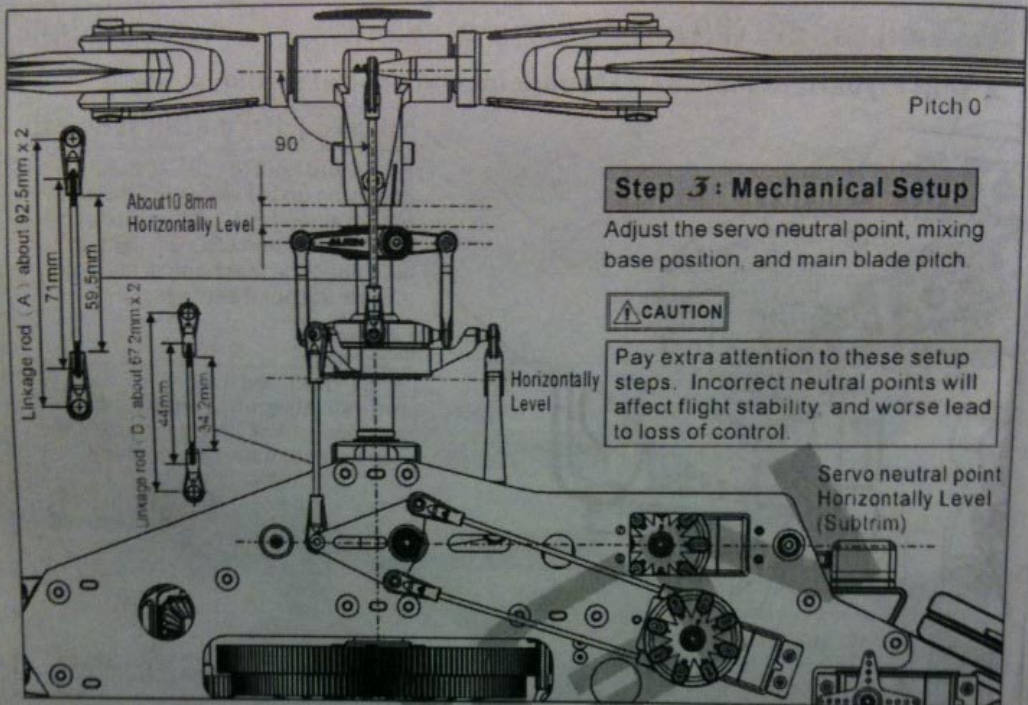

Step 3: Mechanical Setup

Adjust the servo neutral point, mixing base position, and main blade pitch

CAUTION

Pay extra attention to these setup steps. Incorrect neutral points will affect flight stability, and worse lead to loss of control.

Servo neutral point
Horizontally Level
(Subtrim)

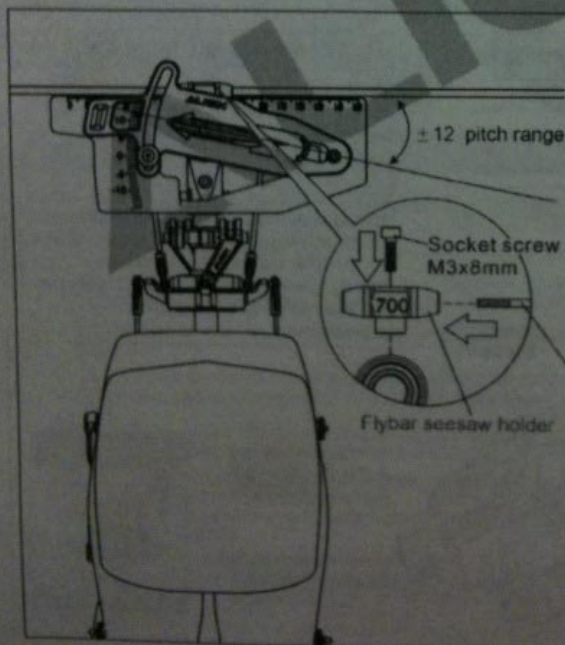

Step 4: Main blade pitch setup

Recommended pitch range $\pm 12^\circ$
maximum pitch range for advanced pilot shall not exceed $\pm 14^\circ$

CAUTION

Adjustments to the CCPM servos endpoints should be done through transmitter's swashplate mixing function (Pitch swash AFR). Do not adjust individual servos endpoints through the servo ATV/AFR function. Should any changes made to the endpoints or subtrims on the transmitter in the future, the flybarless system initial setup must be performed again.

Use the original #4 flybar

Use the included temporary flybar mount and the original flybar to aid the adjustment of pitch

CAUTION

If there are bite marks from the setscrew on your flybar, sand it smooth with sandpaper or file for ease of insertion into the temporary flybar mount.

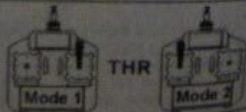

Step 5 : pitch range setup

Maximum cyclic pitch setup. With main blade parallel to helicopter body, move the transmitter aileron stick all the way left, and adjust the AIL mixing percentage in SWASH settings until main blade pitch are 12 to 14 degrees.

※ **Recommended** pitch range $\pm 12^\circ$, maximum pitch range for advanced pilot shall not exceed $\pm 14^\circ$.

CAUTION

Adjustments to the CCPM servos endpoints should be done through transmitter's washplate mixing function (Pitch swash AFR). Do not adjust individual servos endpoints through the servo ATV/AFR function. Should any changes made to the endpoints or subtrims on the transmitter in the future, the flybarless system initial setup must be performed again.

Example: cyclic pitch of 12°
Futaba 12ZH with three DS610's
AILeron swash AFR : 60% (12°)
Elevator swash AFR : 60%
Pitch swash AFR : 38% ($\pm 12^\circ$)

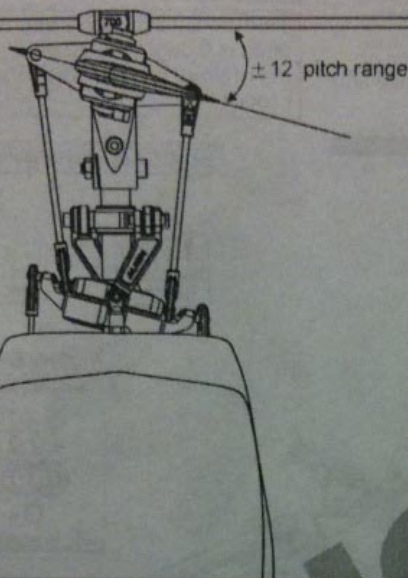

2.E.LIM swashplate mixing type recognition and elevator endpoint setup :

Step 1 : Entering E.LIM setup mode

While keeping washplate level and main pitch at zero degrees, press the SET button to enter E.LIM setup mode. The E.LIM LED will lit up after DIR turns off.

CAUTION

The throttle stick position where main pitch is 0 degree must be maintained through this setup process.

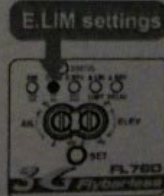
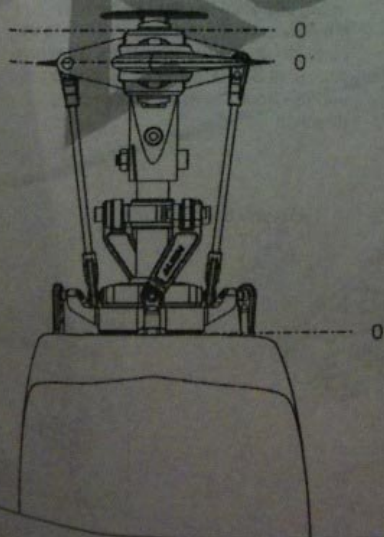

Step 2: Swashplate mixing type recognition and elevator endpoint setup

With all channels stationary, move the transmitter elevator stick **forward**, and then back to center position. This completes the swashplate mixing type recognition process.

The control unit will determine the CCPM mixing ratio or traditional mechanical mixing maximum elevator endpoints.

CAUTION

Throttle stick position where main pitch is 0 degree must be maintained through this setup process

throttle stick must be maintained

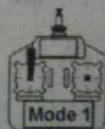

ELE



E.LIM settings

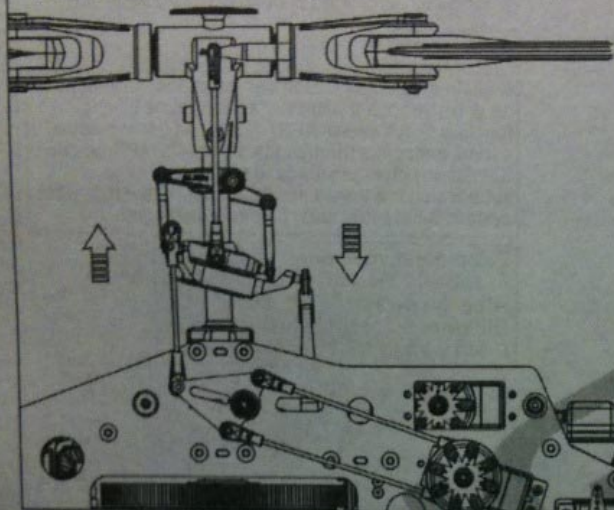
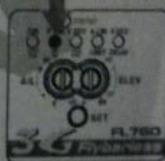

3. E.REV elevator reverse setup mode :

Press the SET button to enter E.REV setup mode.

The E.REV LED will lit up after E.LIM turns off.

This setup mode sets the elevator gyro direction

1. Tilt the helicopter forward as shown in diagram, and check if swashplate is tilting correctly toward the back.
2. If the swashplate is tilting at the wrong direction, move the transmitter elevator stick until STATUS LED changes color, and re-check the swashplate tilting direction.

Swashplate correction direction

Helicopter tilting direction

Helicopter tilting direction

E.REV settings

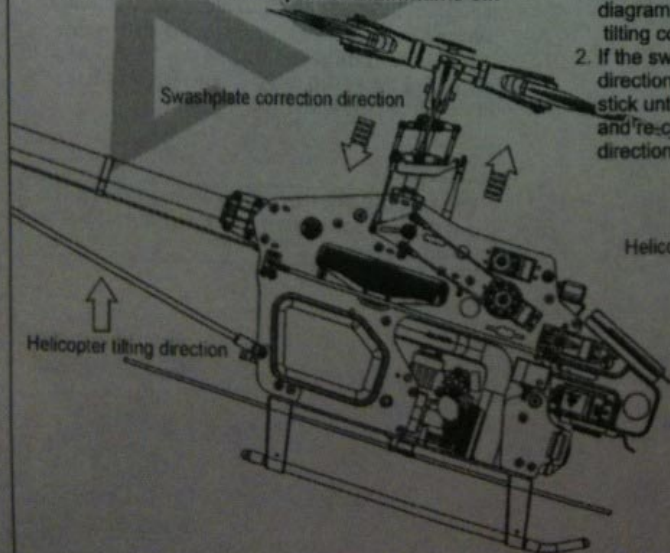

4. A.LIM aileron endpoints setup:

Press the SET button to enter A.LIM setup mode. The A.LIM LED will lit up after E.REV turns off. With all channels stationary, move the transmitter aileron stick to the right, and then back to center position. This completes the aileron endpoint setup process. The control unit will determine the maximum aileron endpoints

CAUTION

The throttle stick position where main pitch is 0 degree must be maintained through this setup process

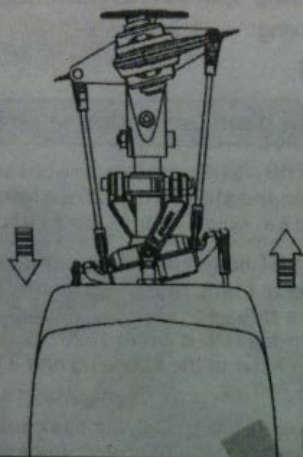

throttle stick must be maintained

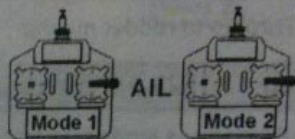

A.LIM settings



5. A.REV aileron reverse setup mode:

Press the SET button to enter A.REV setup mode. The A.REV LED will lit up after A.LIM turns off.

Tilt the helicopter right as shown in diagram, and check if swashplate is tilting correctly toward the left. If the swashplate is tilting at the wrong direction, move the transmitter elevator stick until STATUS LED changes color, and re-check the swashplate tilting direction.

Press the SET button again, and the control unit will restart, with all LED's flashing.

CAUTION

3G Flybarless system must remain stationary during startup. Do not move the helicopter until the swashplate jumps up and down slightly 3 times, indicating the completion of initialization. (please refer to page 17 step 3)

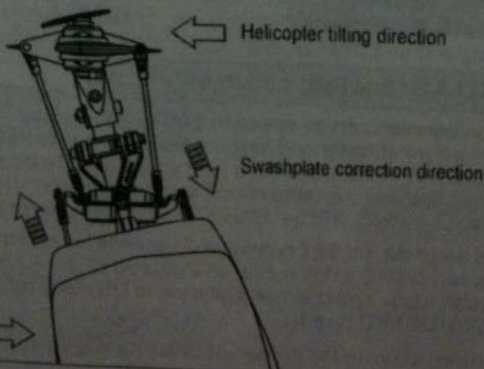

A.REV settings



RUDDER GYRO SETUP

After the system reboots, flybarless setup is completed. Now the rudder gyro needs to be setup with similar procedure as Align's GP780 gyro. Push and hold the SET button for 2 seconds to enter the rudder gyro setup mode.

If your transmitter has the following settings, please disable it or set the value to zero.

- ATS
- Rudder to gyro mixing
- Pilot authority mixing
- Pitch to rudder mixing
- Throttle to rudder mixing
- Revolution mixing

CAUTION

3G Flybarless rudder gyro has the factory setting of 1520 μ s and DS digital servo. Double check your servo spec and change the gyro setting as needed to avoid damages to the servo.

Step 1 : 1520 μ s (standard) or 760 μ s (narrow band) servo frame rate setup.

3G Flybarless system is compatible with both the 760 μ s narrow frame rate servos (such as Futaba S9256, S9251, BLS251), as well as the standard 1520 μ s frame rate servos (most others). Proper frame rate must be selected based on your servo's specifications.

To enter the setup mode : Press and hold the SET button for 2 seconds until STATUS LED flashes. The 1520/760 LED will light up indicating servo frame rate setup mode. Push the transmitter rudder stick left or right to select the frame rate. For example, if rudder is pushed to the left (or right) and STATUS LED turns green, the frame rate is set to 1520 μ s. To set it to 760 μ s, the rudder stick needs to be pushed from the center to the opposing end 3 times for the STATUS LED to turn red, indicating frame rate set to 760 μ s.

3G Flybarless panel : Each setting value is labeled on the 3G flybarless control unit with either green or red lettering, which corresponds to the STATUS LED color. Subsequent setup mode is entered by a single press of the SET button. Setup mode will exit if no activity is detected in 10 seconds.

Green LED : 1520 μ s standard band
Red LED : 760 μ s narrow band



Standard/Narrow band mode

Select by moving the rudder stick left and right



Step 2 : DS (digital) / AS (analog) servo selection

There is a direct correlation between servos' speed to gyro's performance. Faster servos are able to execute commands from the gyro at faster and higher precision. Due to the high performance gyro sensors used in the 3G flybarless system, premium high speed digital rudder servos are mandatory for optimal tail performance. Some of the recommended rudder servos include Align DS650, DS620, DS520, DS420, Futaba S9257, S9256, S9254, S9253, or other servos with similar specifications.

Setup method : Press and hold the SET button for 2 seconds to enter the setup mode, then press the SET button to select DS/AS setup mode, as indicated by the lighting of DS/AS LED. Using the transmitter's rudder stick, select either digital servo DS mode (STATUS LED is green), or analog servo AS mode (STATUS LED is red).

CAUTION

Using an analog servo in DS mode will cause damages to the servo.

- (2) The DELAY function is utilized when slower rudder servo causes tail hunting (wagging). This can be observed after a hovering pirouette comes to a stop. If tail hunting occurs, gradually increase DELAY value to eliminate it. For best performance, DELAY value should be kept as low as possible without tail hunting.

Setup method : Press and hold the SET button for 2 seconds to enter the setup mode, then press the SET button to select DELAY setup mode, as indicated by the lighting of DELAY LED. The choice of small or large helicopter is done by moving the transmitter rudder stick left or right while observing the color of the STATUS LED. For small helicopters STATUS LED will be red, and large helicopter will be green. The amount of servo delay is set by how far you push the rudder stick, followed by pushing the SET button.

Green LED for T-REX700



0% when DELAY LED begins flashing

Gradually move the transmitter rudder stick until DELAY LED begins to flash, the delay value is 0% at this point.



Green LED for T-REX700



Continue to move the rudder stick until desired delay value is needed, then press the SET button to register the setting. Maximum is 100% delay, with rudder stick pushed to the end.



Step 7: Sensitivity Adjustment

For radio with built in gyro gain settings, gain can be adjusted directly. For example, 50%-100% setting on the radio translates to 0%-100% gain in the heading lock mode. 50%-0% setting on the radio translates to 0%-100% gain in the normal (non-heading) lock mode.

Actual gain value differs amongst servos and helicopters. The goal is to find the maximum gain without tail hunting. This can only be done through actual flight tests.

The recommended starting point for transmitter's gyro gain setting should be 70-80% for hovering, 60-70% for idle-up. Value should be tuned under actual flight conditions by increasing to the maximum gain without tail hunting.

CAUTION

For radios (IE Futaba) using 0-100% as heading lock gain scales, the recommended gain setting is 30% to 35%. For radio that uses the 50-100% scale (such as JR and Hitac), the recommended gain setting is 70% to 75%.

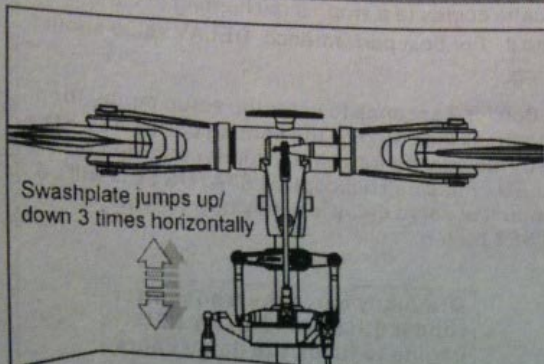

Swashplate jumps up/
down 3 times horizontally

Step 1

Turn on Transmitter, and then receiver power.

Step 2

3G Flybarless system will go through initialization process, as indicated by flashing of all LED's. Do not move the helicopter or transmitter sticks until initialization process completes.

Step 3

The completion of initialization process is indicated by the rapid up and down motion of swashplate 3 times while remaining level. Should the swashplate jumps up and down at a tilted position, the flybarless system initial setup need to be performed again (Refer to page 8: Flybarless system initial setup)

The pitch of helicopter will remain locked until successful initialization. If the initialization process is unable to complete, with STATUS LED blinking red, Re-check all connections, and perform another reboot with helicopter remain stationary.

Following successful initialization process, green STATUS LED indicates rudder is in heading lock mode, while red LED indicates normal non-heading mode. (Refer to P.16 Gain Adjustment)

Green = rudder in heading lock mode
Red = rudder in normal mode



○ Swashplate jumps up and down 3 times horizontally represents successful initialization.



✗ Swashplate jumps up and down 3 times tilted represents setup error.



Step 4

Tilt the helicopter forward and swashplate should tilt back to compensate. If reversed, perform the flybarless initial setup again and adjust the elevator reverse setting (Refer to P.11: E:REV setup)

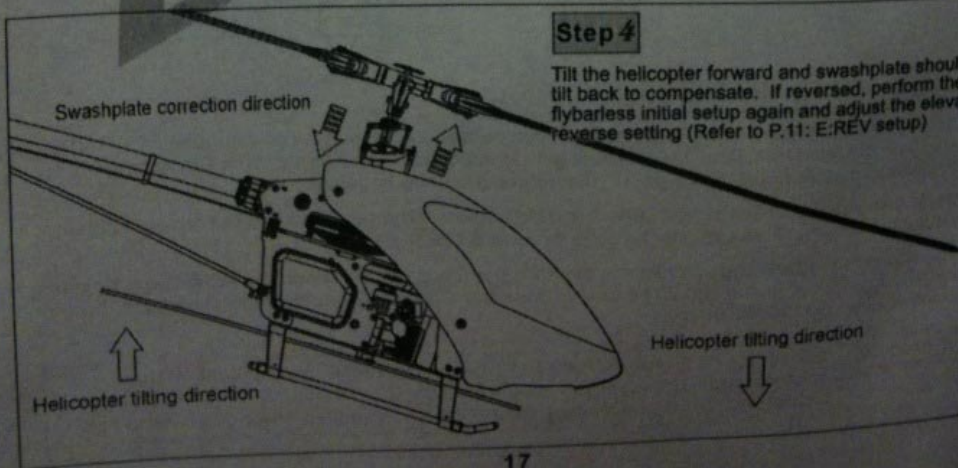

Swashplate correction direction

Helicopter tilting direction

Helicopter tilting direction

Step 5

Tilt the helicopter to the right and swashplate should tilt left to compensate. If reversed, perform the flybarless initial setup again and adjust the aileron reverse setting (Refer to P 12: A REV setup)

Step 6

With throttle stick all the way up (and down), and cyclic stick all the way left/right and up/down, check for any binding on the swashplate. If binding occurs, perform the flybarless initial setup again and adjust the endpoint limits.

Step 7

Check the center of gravity (CG) and adjust component placement until CG point is right on the main shaft of the helicopter.

Step 8

With all above steps checked, restart the system and begin flight test.

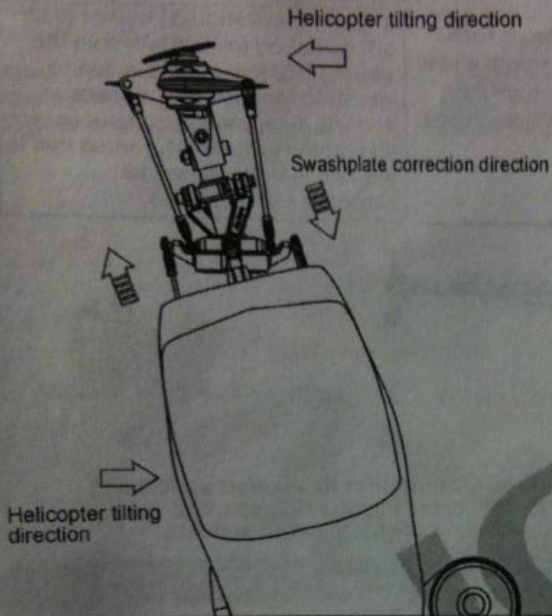

HELICOPTER CG CHECK PROCEDURE

With a full fuel tank, hold the helicopter as shown. Once the helicopter stops rotating, the helicopter's CG can be seen at where the head is pointing relative to the main shaft.

Helicopter head should be level with main shaft, or slightly lower than the main shaft.

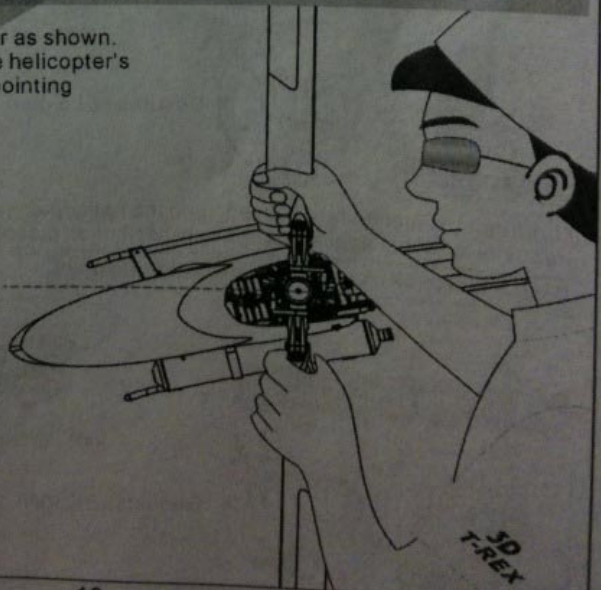

Step 1

This procedure is best performed on soft surfaces such as grass. The use of rubber skid stopper is recommended on hard surface to prevent vibration feedback from the ground to flybarless sensors, resulting in over-corrections.

Rubber skid stoppers installed

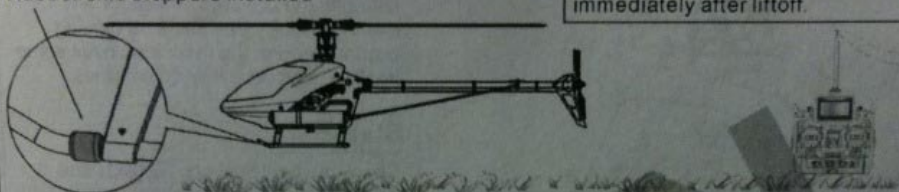

CAUTION

If swashplate should tilt prior to lift off, do not try to manually trim the swashplate level. This is due to vibration feedback to the sensor, and will disappear once helicopter lifts off the ground. If manual trim is applied, helicopter will tilt immediately after liftoff.

Step 2

With the helicopter hovering, observe for any rapid left/right or forward/aft oscillations. If forward/aft oscillation is observed, land the helicopter, turn the ELE gain dial counterclockwise gradually, and test again. Do this until oscillation disappears.

Set the dial to 12 o'clock position as starting point

Elevator gain adjustment dial

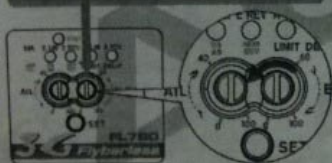

Decrease ELE gain

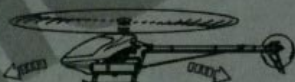

Left/right oscillation



If left/right oscillation is observed, land the helicopter, turn the AIL gain dial counterclockwise gradually, and test again. Do this until oscillation disappears.

Set the dial to 12 o'clock position as starting point

Aileron gain adjustment dial

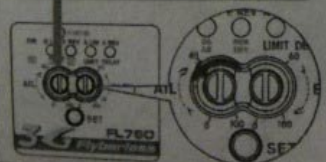

Decrease AIL gain

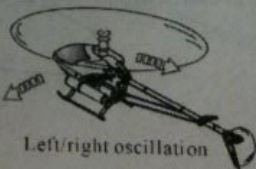

Left/right oscillation



FORWARD STRAIGHT LINE FLIGHT

Put the helicopter into fast forward flight from hovering. If similar oscillation is observed, reduce the elevator gyro gain. If the helicopter pitches up, or responds slowly, increase the elevator gyro gain. Repeat test until the oscillation is eliminated. Similar method is used for aileron gyro gain.

After gyro gain adjustments are completed, the helicopter cyclic rate can be tuned using transmitter's swash AIL and ELE mixing ratio. Higher the percentage, faster the roll/flip rate. Exponential can also be added on the transmitter to soften the sensitivity for stable hover.



← Forward Flight



11 SETUP EXAMPLES

ALIGN

Using Futaba 12ZH transmitter as an example

	Normal Flyer : with emphasis on stability	Advanced Flyer : with emphasis on agility
Main blade pitch Settings (Collective Pitch Settings)	Main blade pitch : 10° ~ 12° swash pitch : 33% ~ 38%	Main blade pitch : 12° ~ 14° swash pitch : 38% ~ 43%
Cyclic pitch settings (Collective Pitch Settings)	Cyclic Pitch 10° swash Aileron : 50% Elevator : 50%	Cyclic Pitch 12° swash Aileron : 60% Elevator : 60%
Aileron and Elevator swashplate mixing ratio settings	swash Aileron : ≦ 50% Elevator : ≦ 50%	swash Aileron : ≦ 60% Elevator : ≦ 60%
Aileron and Elevator gyro gain settings	12 o'clock direction (50%)	11 o'clock direction (40%)

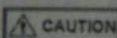

While in DIR setup mode, the transmitter's CCPM swash mixing values for aileron and elevator represent CYCLIC pitch values. These values affect the cyclic roll rates on the aileron and elevator in flying condition. Higher values translate to faster cyclic roll rates. If cyclic roll rate is not improved with increased swash mixing values, this is due to insufficient cyclic pitch. When this happens, cyclic pitch can be increased through the flybarless setup procedure. Maximum cyclic pitch should be limited at 14 degrees.

- Q&A 1** **Pitches up during fast forward flight.**
 (1) Elevator gyro gain too low, increase the elevator gain by gradually turning the ELE dial clockwise.
 (2) Elevator trim not centered. Check if helicopter is tilting backwards during hover.
- Q&A 2** **Insufficient gain during flight, but increasing gain results in oscillation.**
 (1) Check and resolve possible mechanical vibration from helicopter.
 (2) Use softer sensor mounting foam, or double up the stock sensor foam.
 (3) Relocate the sensor to location less prone to vibration.
- Q&A 3** **Drifting during 3D maneuvers.**
 (1) Increase AIL and ELE gain by turning both dials clockwise.
 (2) Check if cyclic servos are too slow (minimum 0.1sec / 60 degrees)
- Q&A 4** **Unstable hover, control inputs are too sensitive.**
 Decrease the aileron and elevator ATV(AFR) value on the transmitter. For CCPM machines, decrease swashplate mixing percentage on the transmitter. In addition, exponential can be added to aileron and elevator channels.
- Q&A 5** **After increasing the ATV(AFR) of aileron and elevator, 3D roll rates are still not enough.**
 Go back through the DIR setup procedure and use larger cyclic pitch.
- Q&A 6** **Helicopter oscillates after fast forward flight or after tumbles.**
 (1) Gradually reduce both AIL and ELE gain by turning them counterclockwise, 10 degrees at a time.
 (2) Use harder head dampener.
- Q&A 7** **While in flybarless setup mode, unable to complete ELE/AIL endpoint and reverse settings.**
 Disable all trims/subtrims on the transmitter.
- Q&A 8** **Incorrect CCPM mixing after initial flybarless setup.**
 (1) Trim/subtrims not zeroed out on transmitter.
 (2) After any trim adjustments are done on transmitter, the initial flybarless setup procedure need to be performed again.
- Q&A 9** **3G flybarless system unable to power up.**
 (1) Check proper voltage source.
 (2) Check AIL/ELE/PIT connections between flybarless control unit and receiver.
 (3) Check for connection between flybarless control unit and sensor.
- Q&A 10** **3G flybarless system powers up with LED flashing, but swashplate did not jump 3 times, pitch is locked, unable to complete the initialization process.**
 (1) Possible movement during initialization process. Make sure helicopter is absolutely stationary.
 (2) If STATUS LED flashes red, check the connection between flybarless controller and sensor.

14 · SPECIFICATIONS

ALIGN

Operating Voltage range	DC 4.5~8.4V	Operating humidity	0%~95%
Operating current consumption	<80mA @ 4.8V	Dimension	Control Unit : 42x26.5x14.5mm
rotational detection rate	± 300° /sec		Sensor : 22.3x21.7x14mm
rudder yaw detection rate	+ 500° /sec	Weight	Control Unit : 16g
Sensor resolution	12bit		Sensor : 9g
Operating temperature	0°C~65°C	●RoHS certification stamp	